

Topological Defects

18.S995 - L23

Order Parameters, Broken Symmetry, and Topology

James P. Sethna

*Laboratory of Applied Physics, Technical University of Denmark,
DK-2800 Lyngby, DENMARK, and NORDITA, DK-2100 Copenhagen Ø,
DENMARK and Laboratory of Atomic and Solid State Physics (LASSP),
Clark Hall, Cornell University, Ithaca, NY 14853-2501, USA*

(Dated: May 27, 2003, 10:27 pm)

dunkel@mit.edu

Topological defects are discontinuities in order-parameter fields

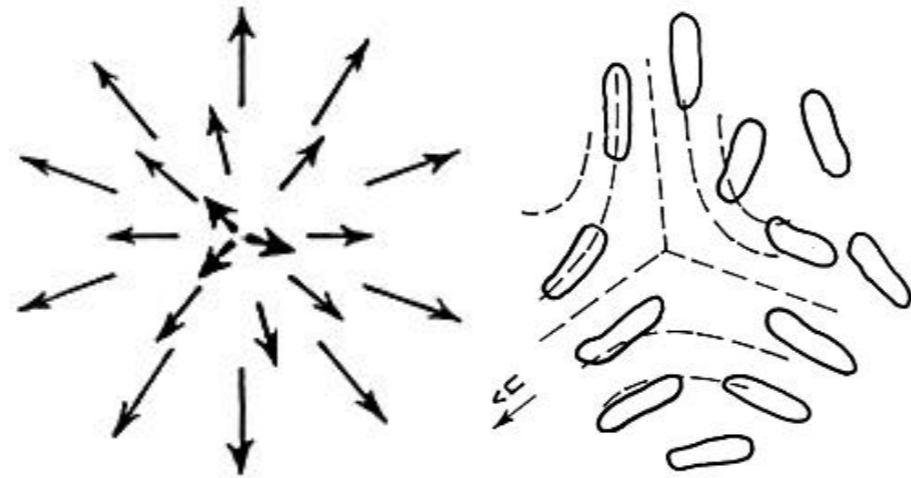

- optical effects
- work hardening, etc

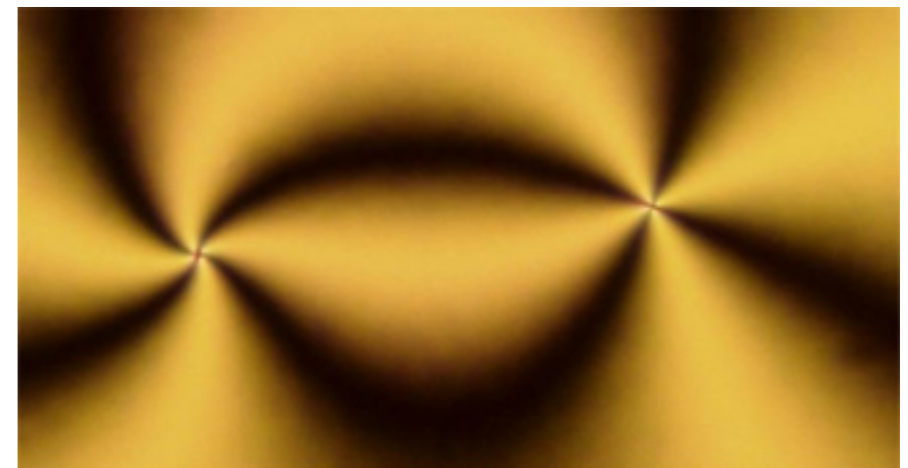

"umbilic defects" in a nematic liquid crystal

order = symmetry = invariance

(under certain group actions)

symmetry groups can be discrete,
continuous, Lie-groups,

More or less symmetric ?

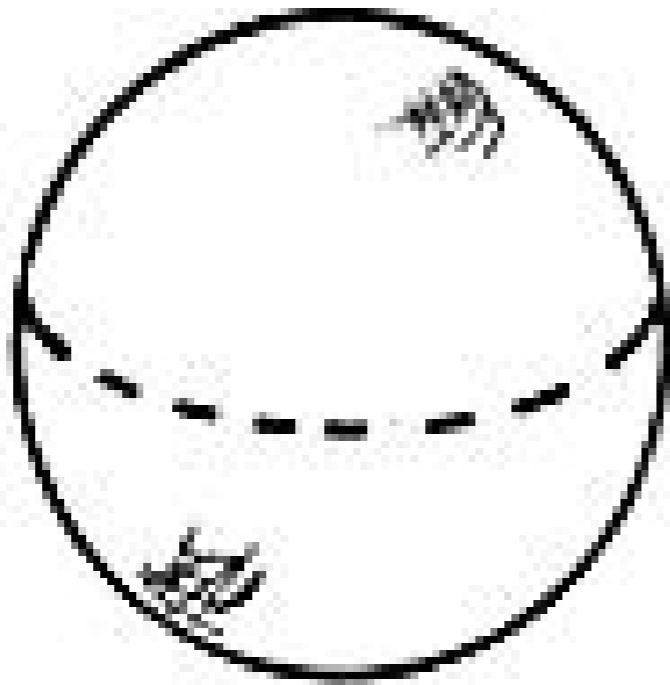

A

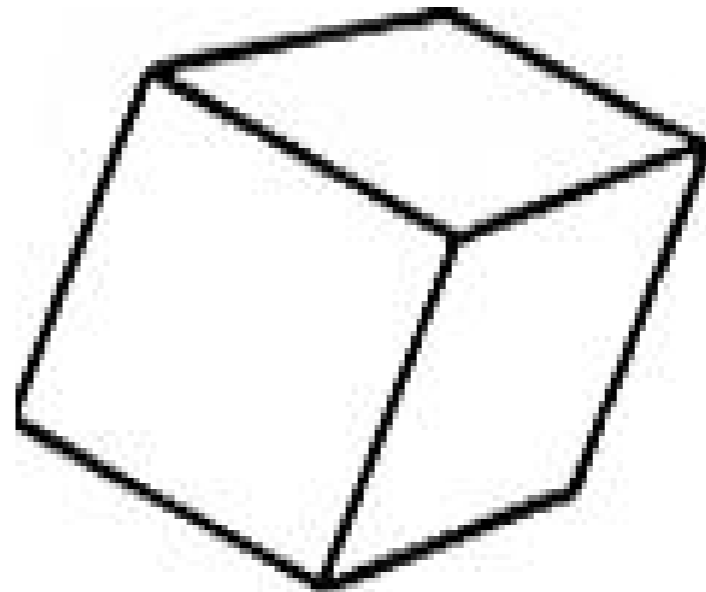

B

More or less symmetric ?

$Mg_2Al_4Si_5O_{18}$

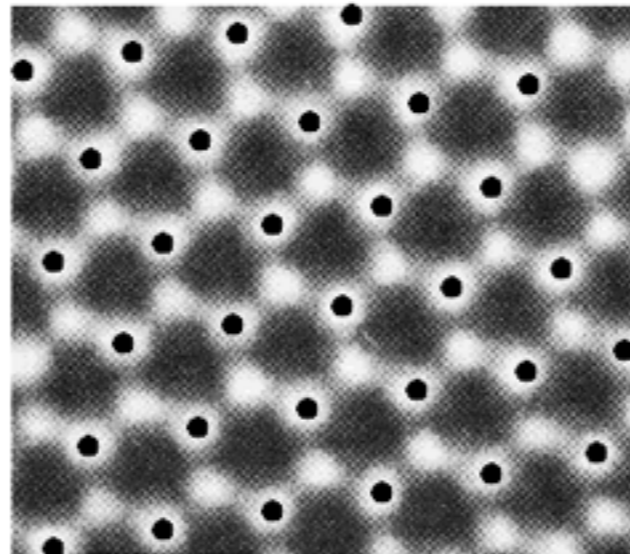
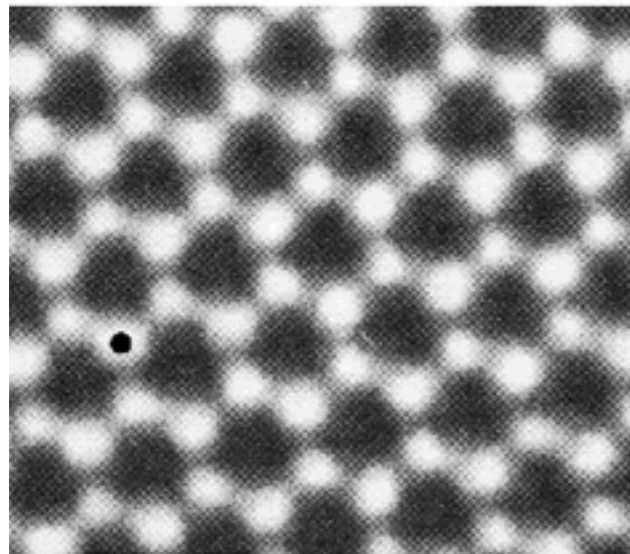
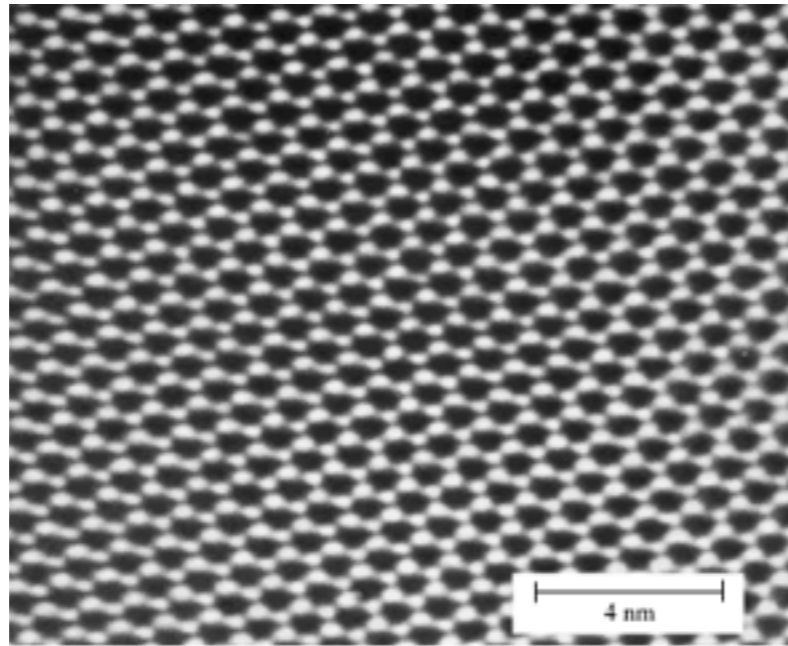

More or less symmetric ?

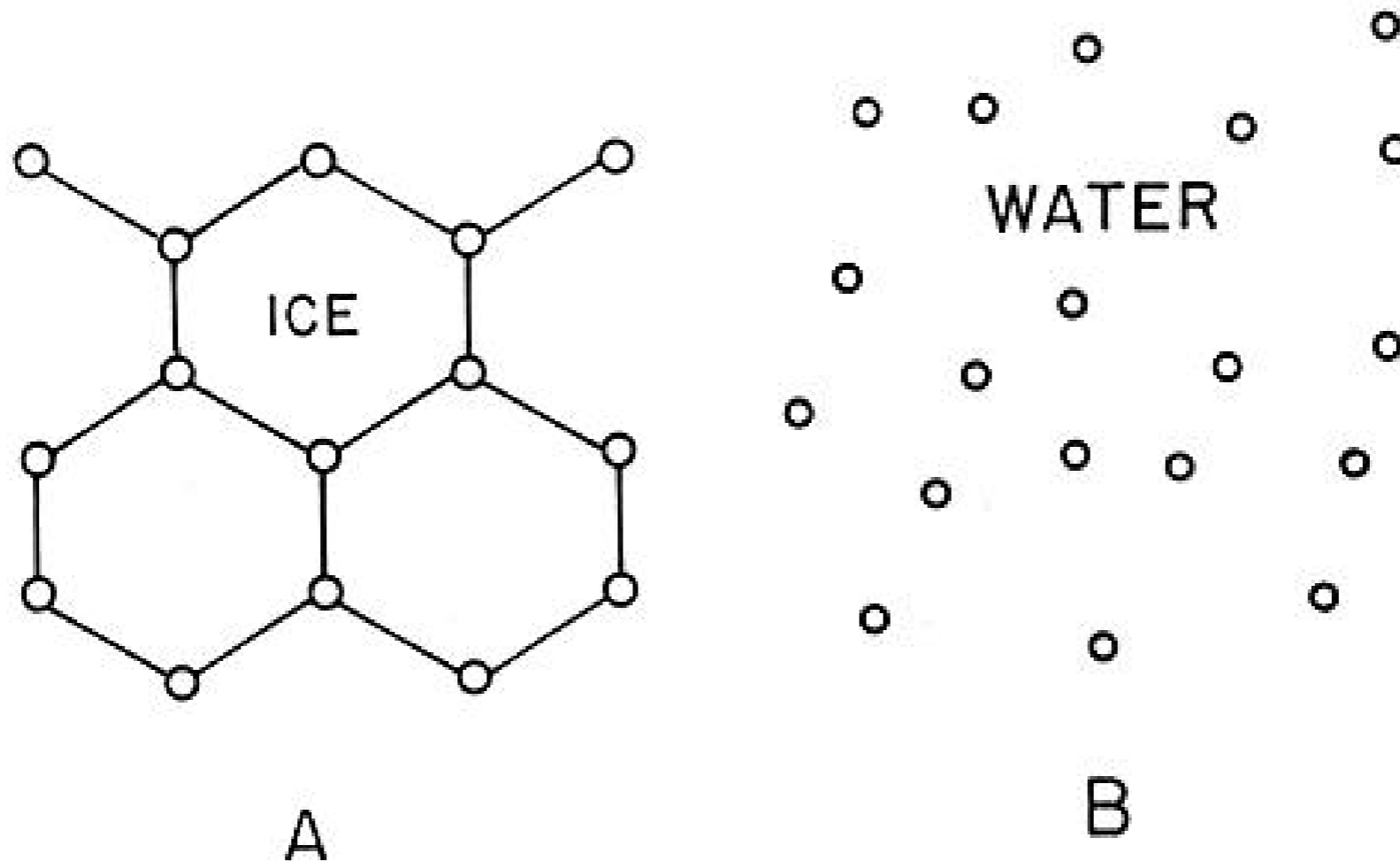

broken continuous
translation/rotation
symmetry (invariance)

Order parameters: 2D crystal

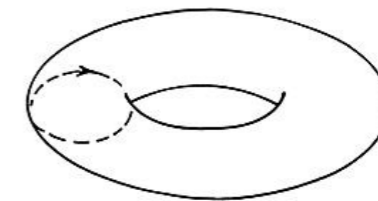
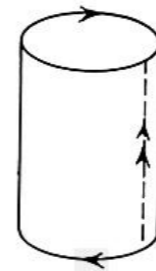
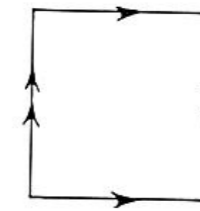
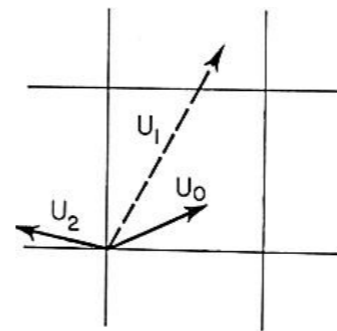
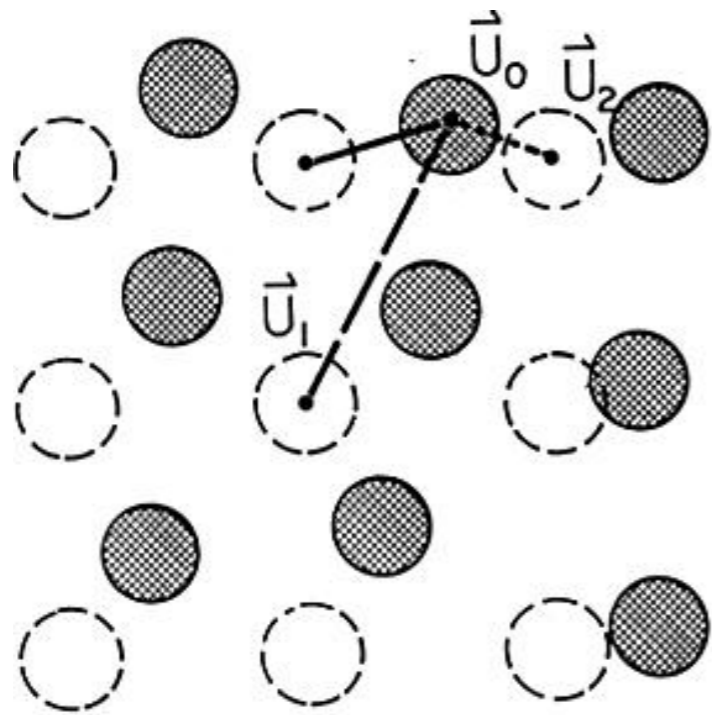

$$\vec{u} \equiv \vec{u} + a\hat{x} = \vec{u} + ma\hat{x} + na\hat{y}.$$

$$\mathcal{E} = \int dx (\kappa/2)(du/dx)^2.$$

Order parameters: magnets

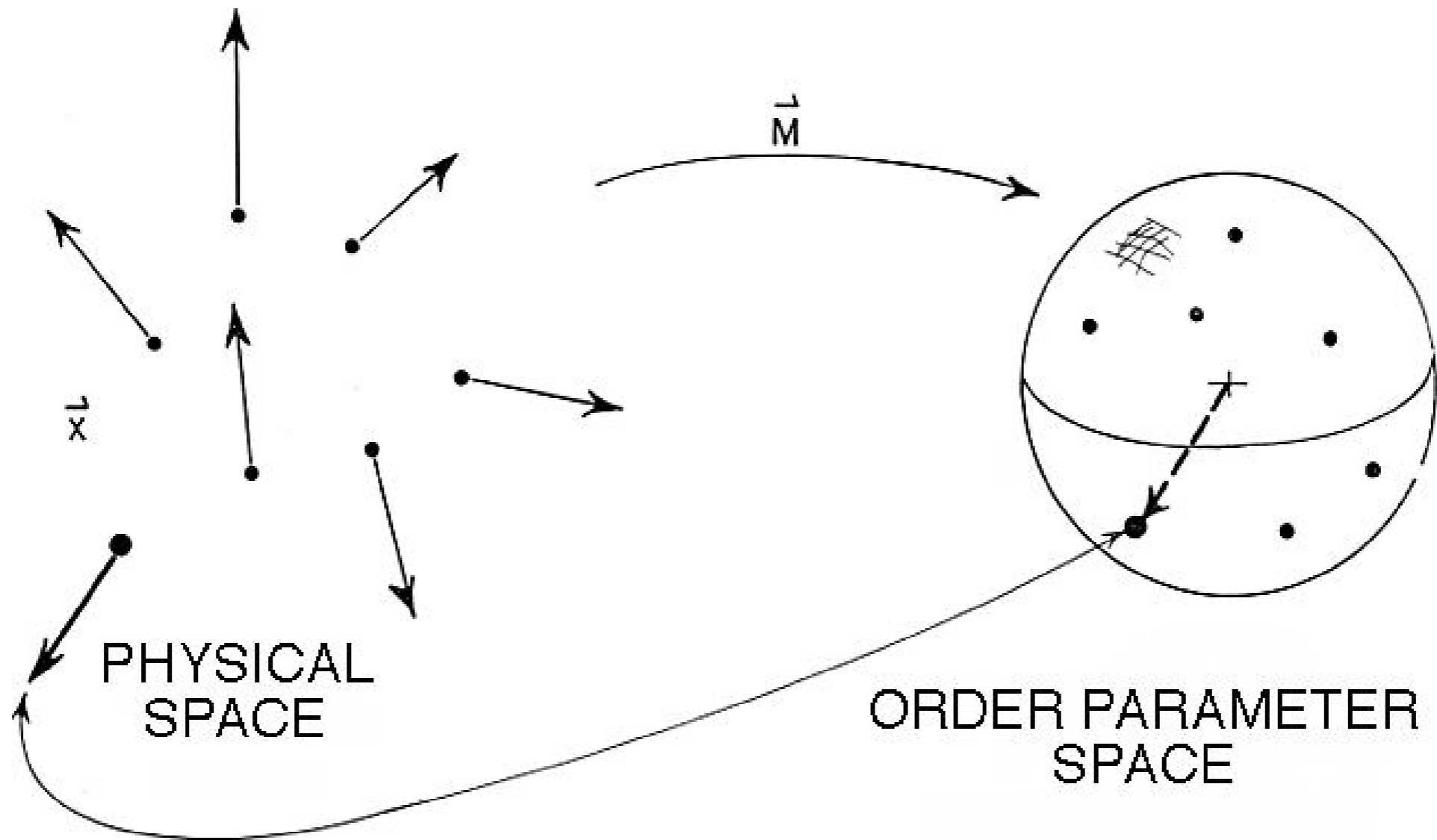

Order parameters: nematic liquid crystals

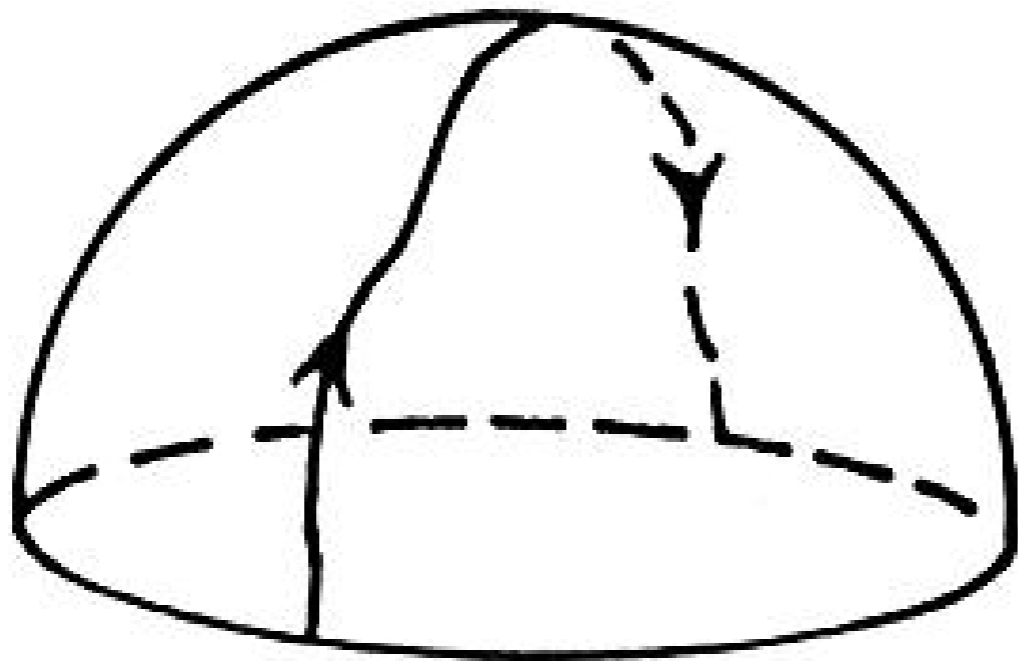

“projective plane” =
half-sphere
with opposite points on
equator identified

Topological defects

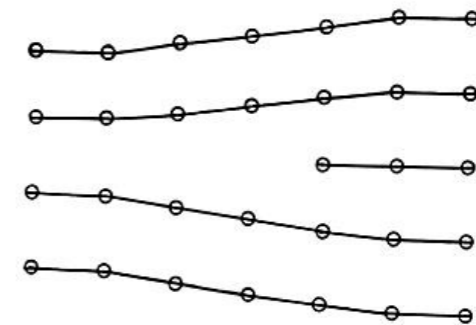
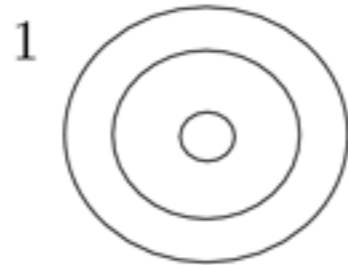
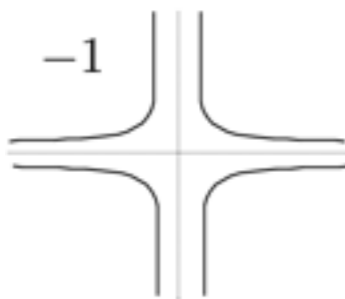
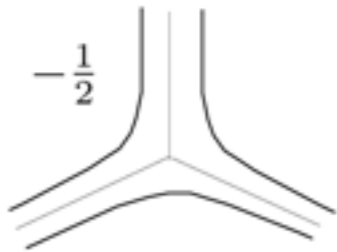
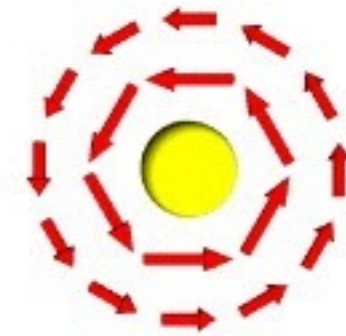
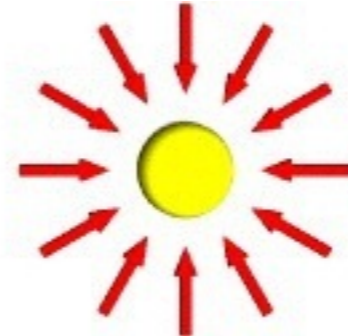
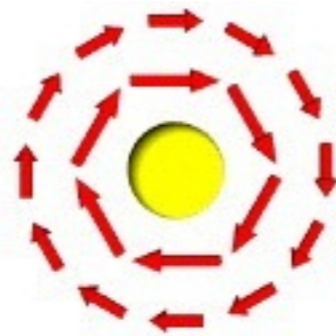
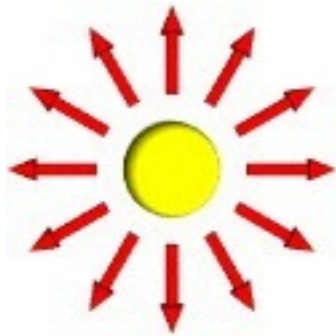

Work hardening

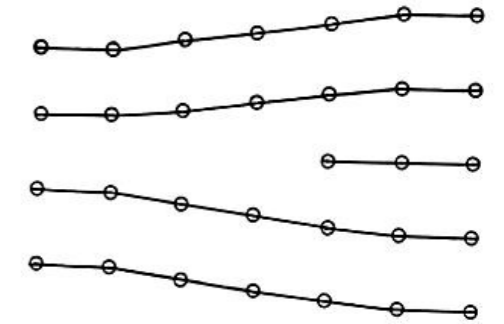

Disclinations

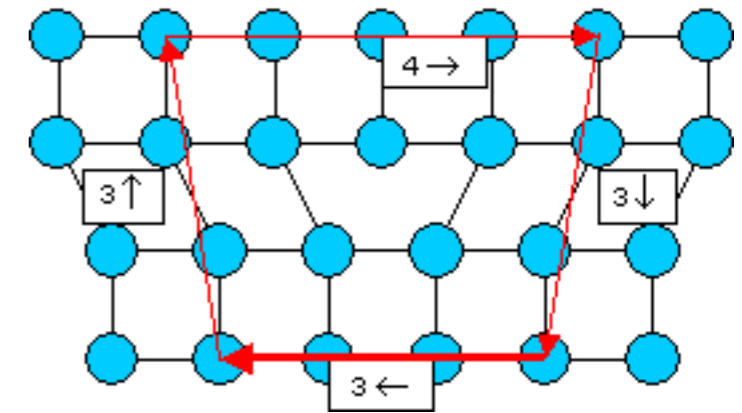
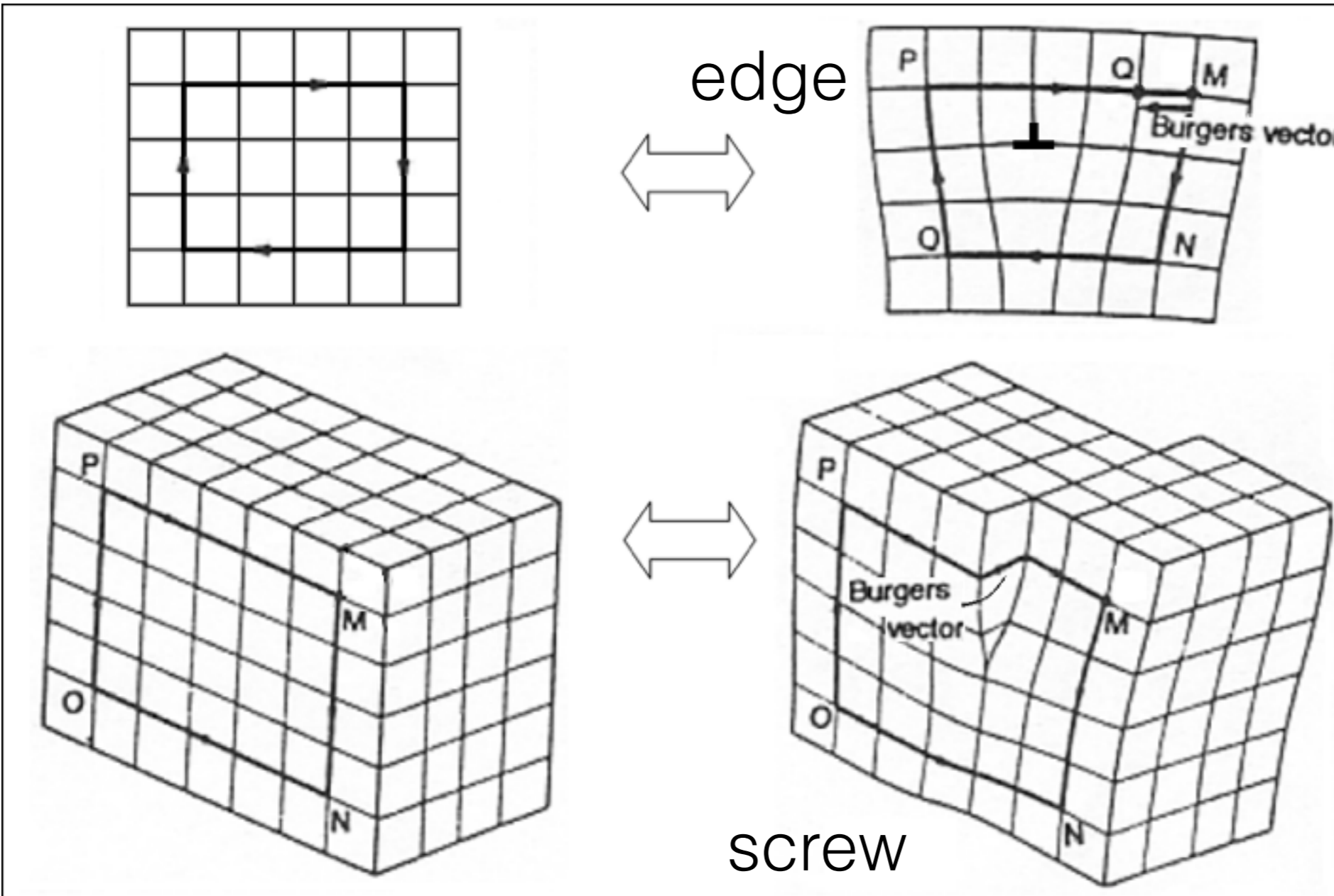
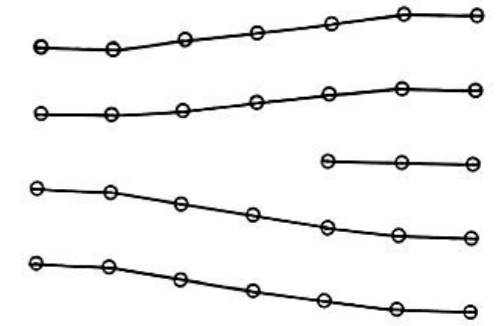

$$\|\mathbf{b}\| = (a/2)\sqrt{h^2 + k^2 + l^2}$$

Disclinations

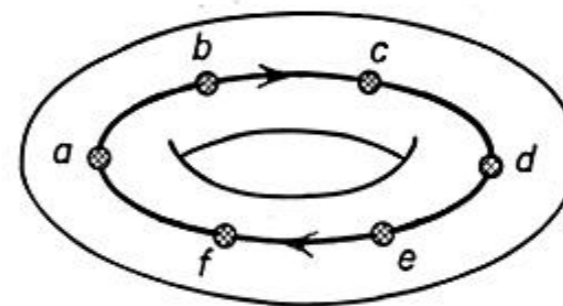
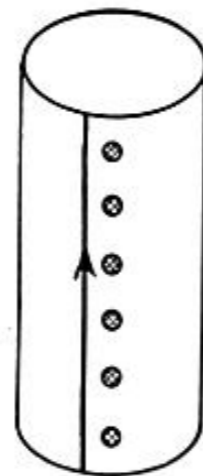
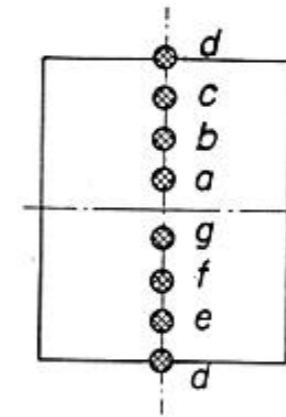
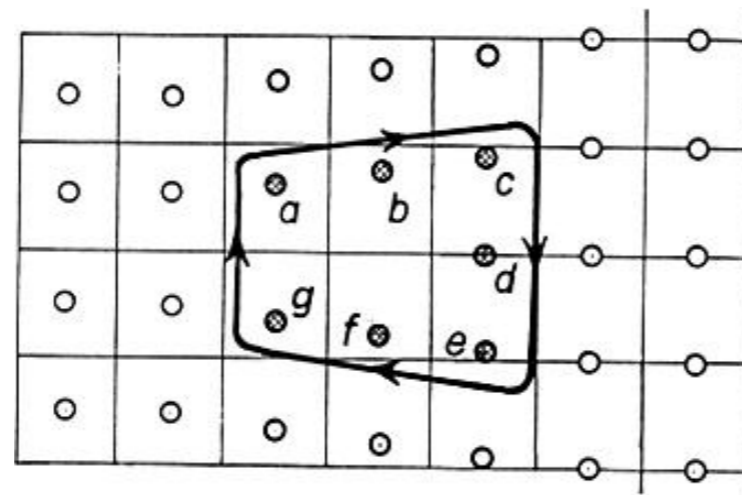
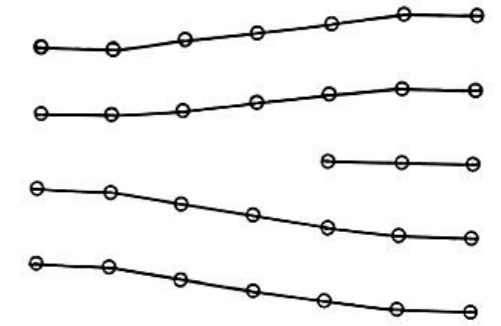

Dislocation-mediated growth of bacterial cell walls

Ariel Amir and David R. Nelson¹

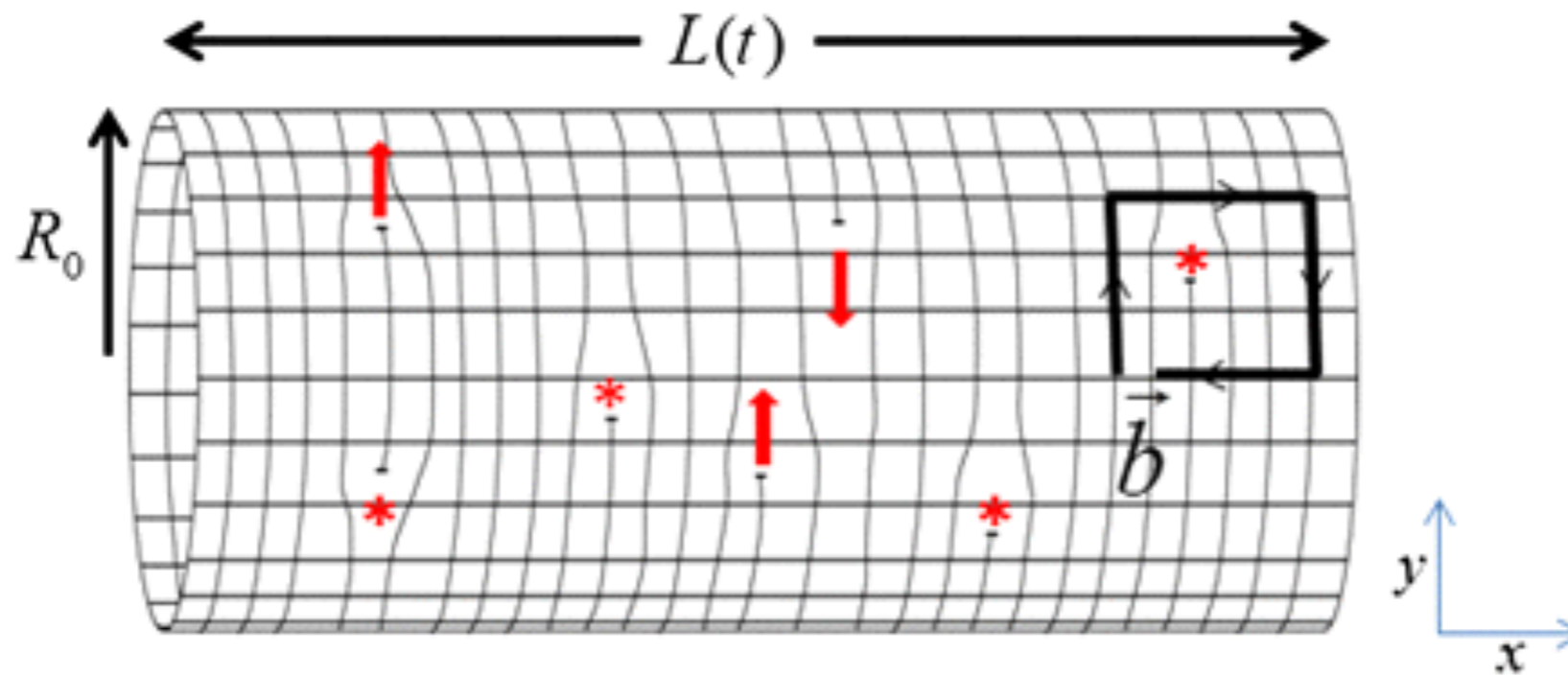

Bacterial vortices

PIV

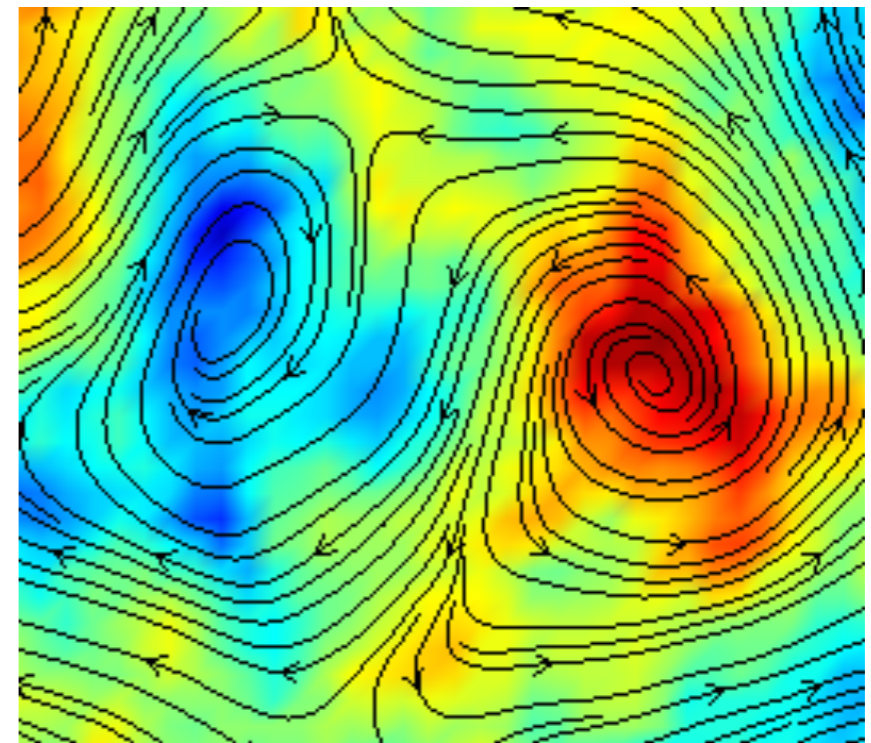
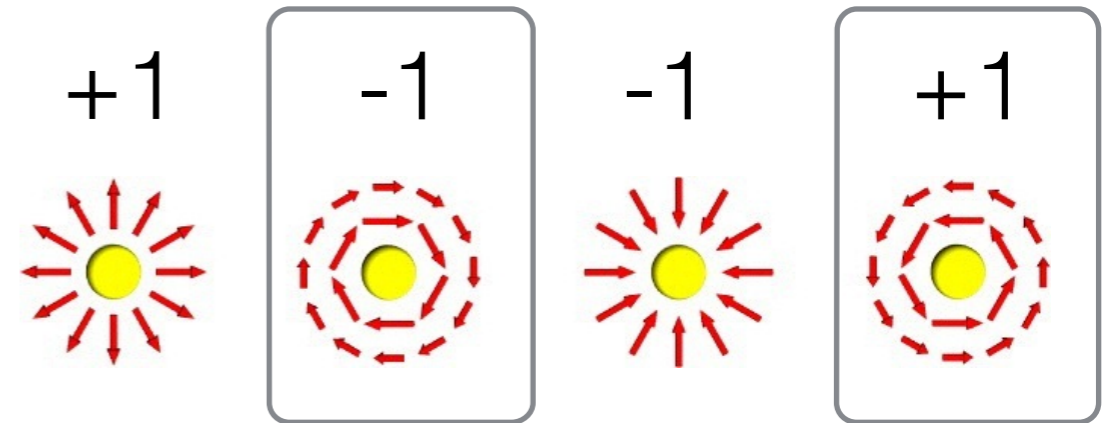
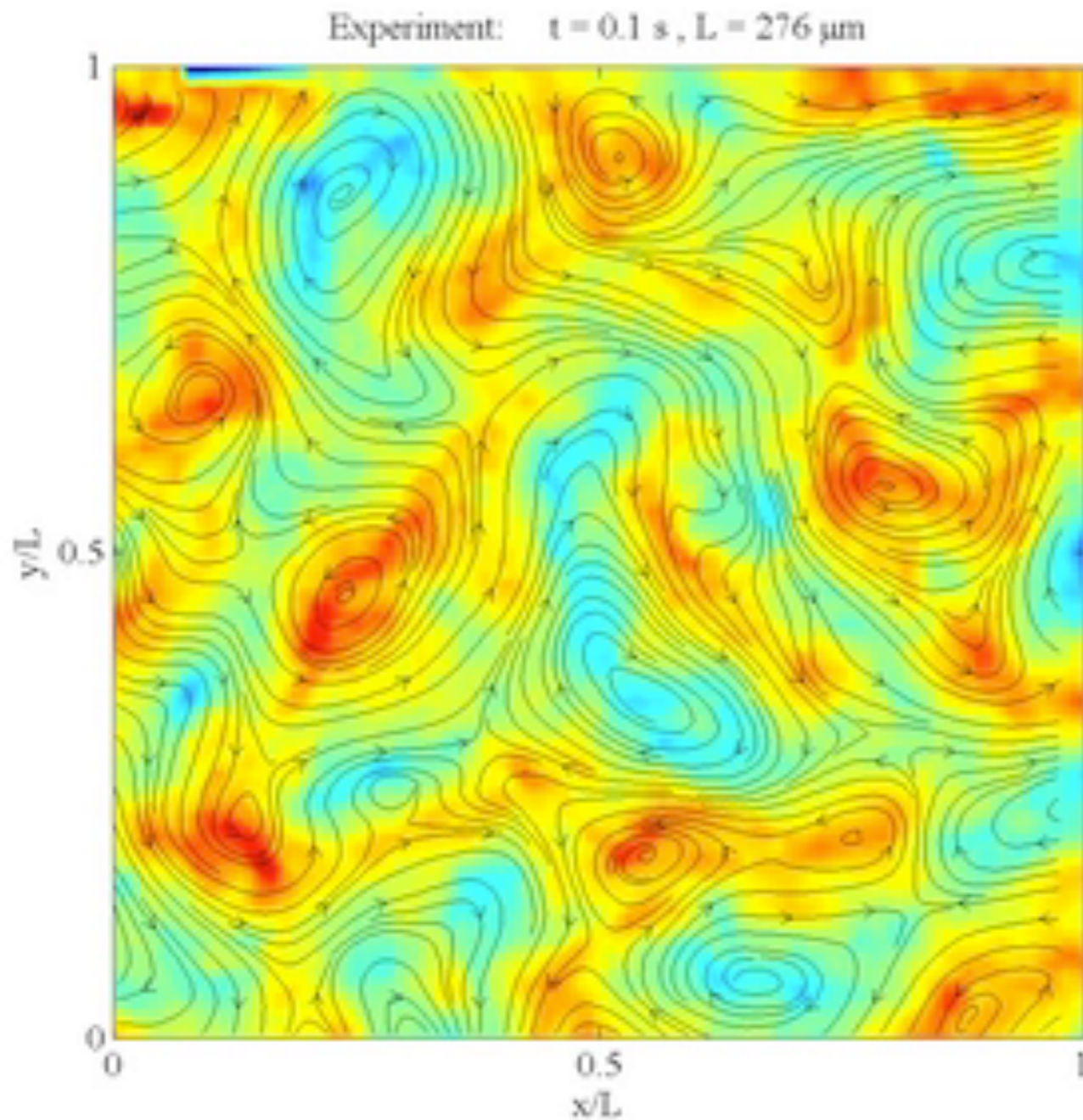

Microtubule asters

mitotic spindle organization

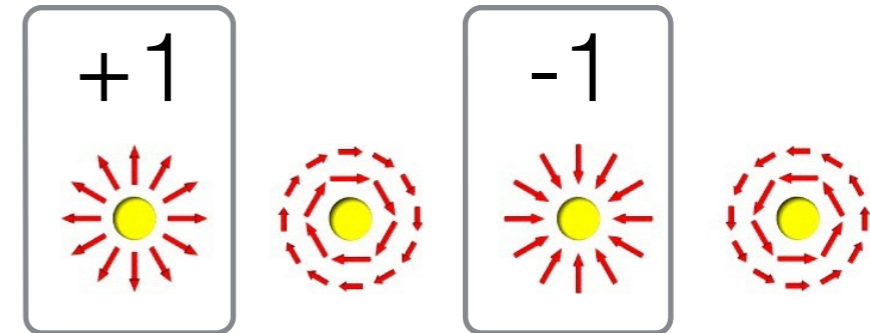

Blower et al (2005) Cell

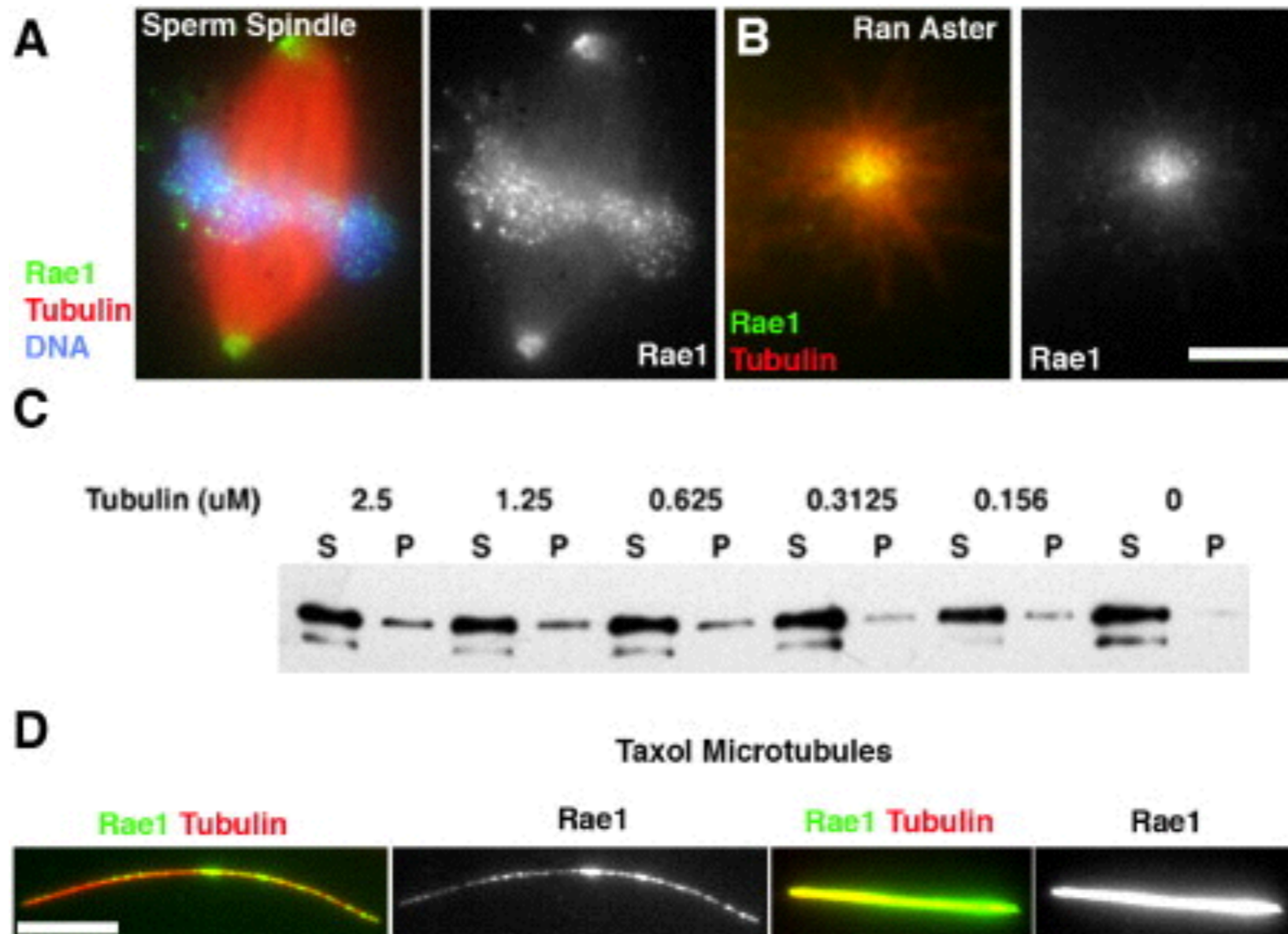

Active nematics

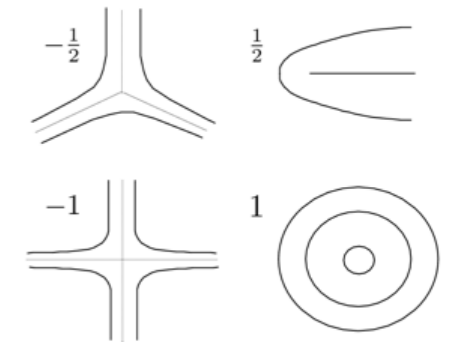
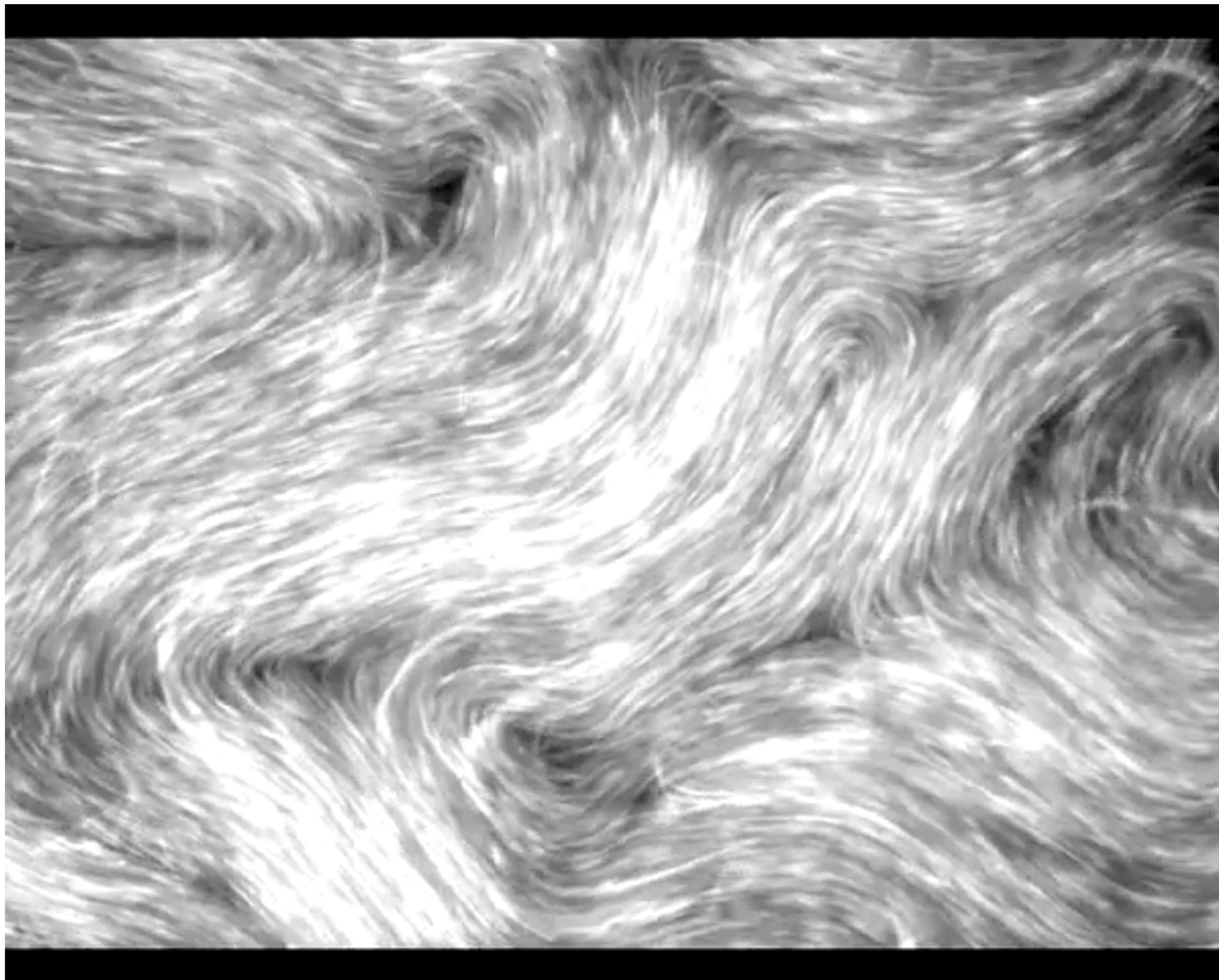

Dogic lab (Brandeis) Nature 2012

Active nematics

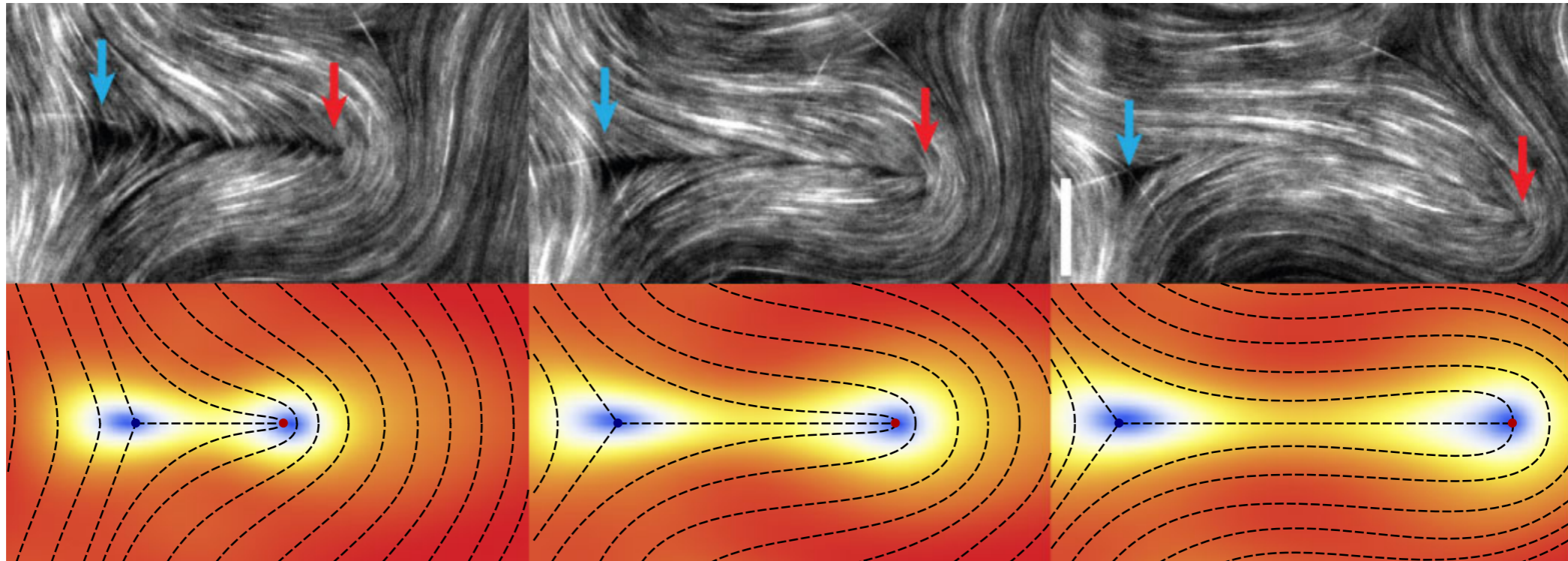
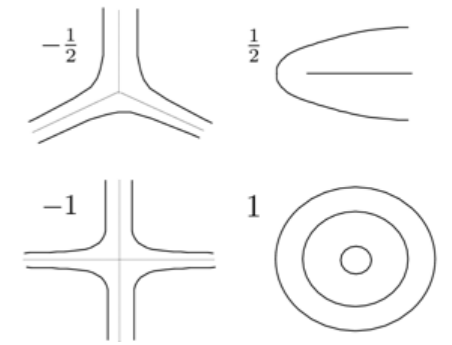

Giomi et al PRL 2012

Defects in nematics

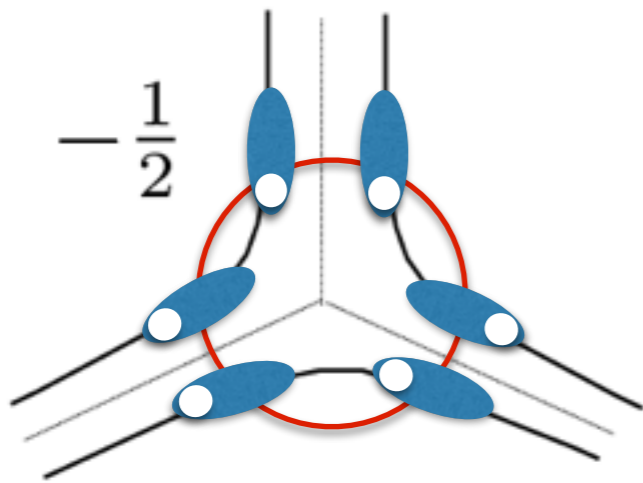

$\frac{1}{2}$

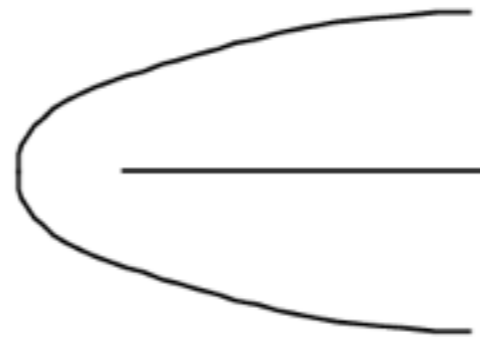

winding
number

-1

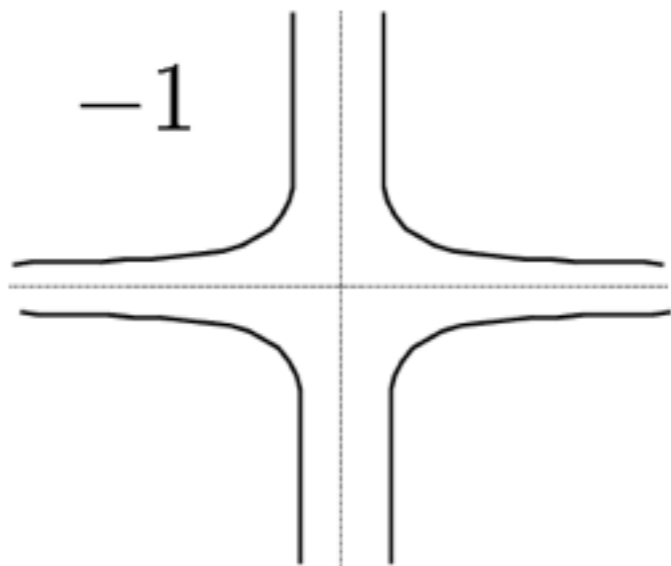

1

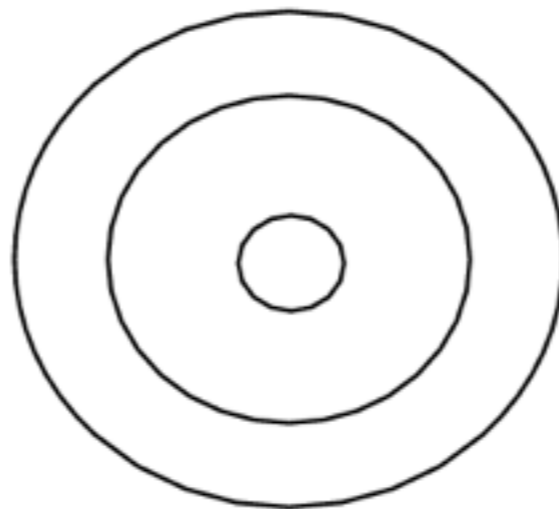

Defects in nematics

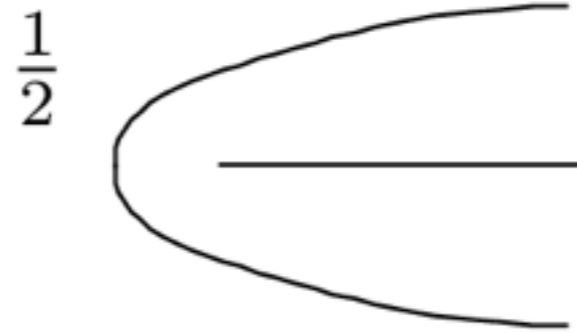
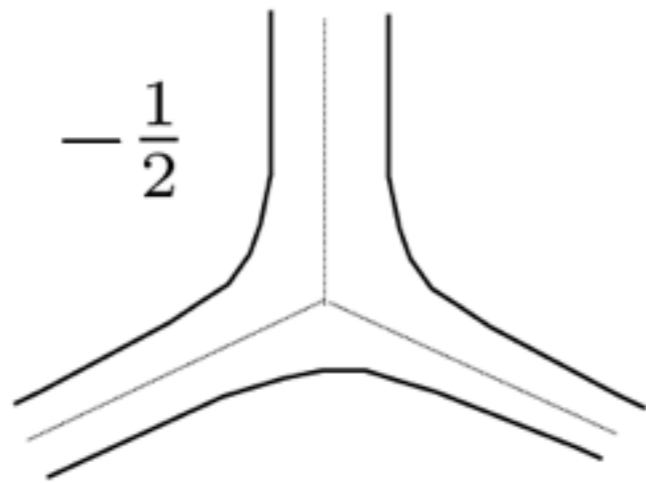

winding
number

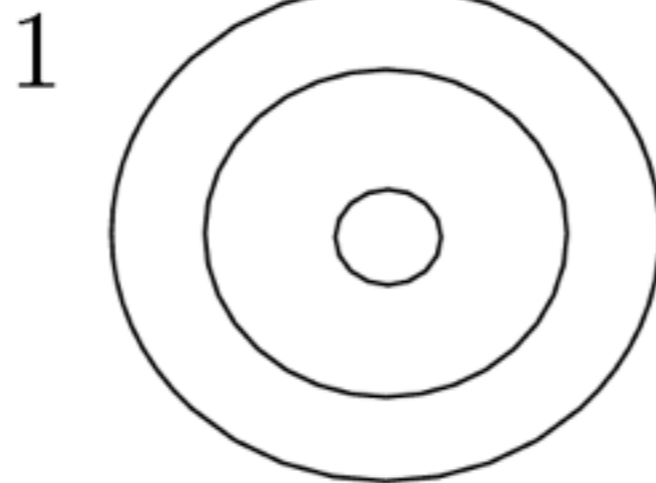
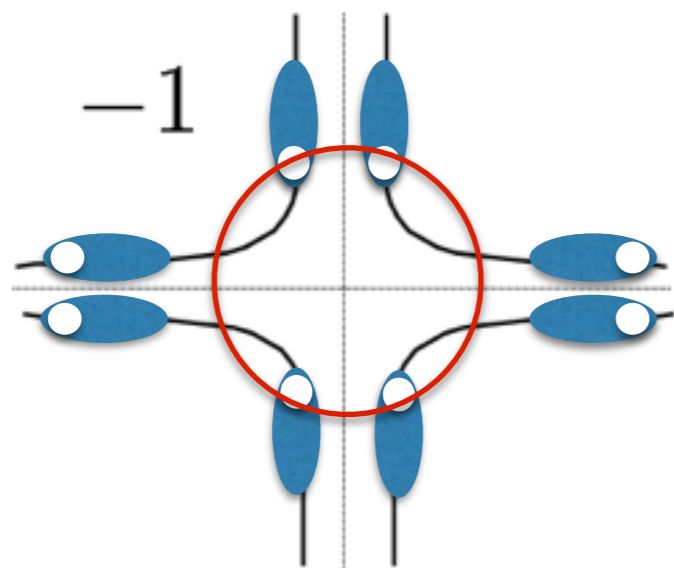

Two-Dimensional Nematic Colloidal Crystals Self-Assembled by Topological Defects

Igor Musevic *et al.*

Science **313**, 954 (2006);

DOI: 10.1126/science.1129660

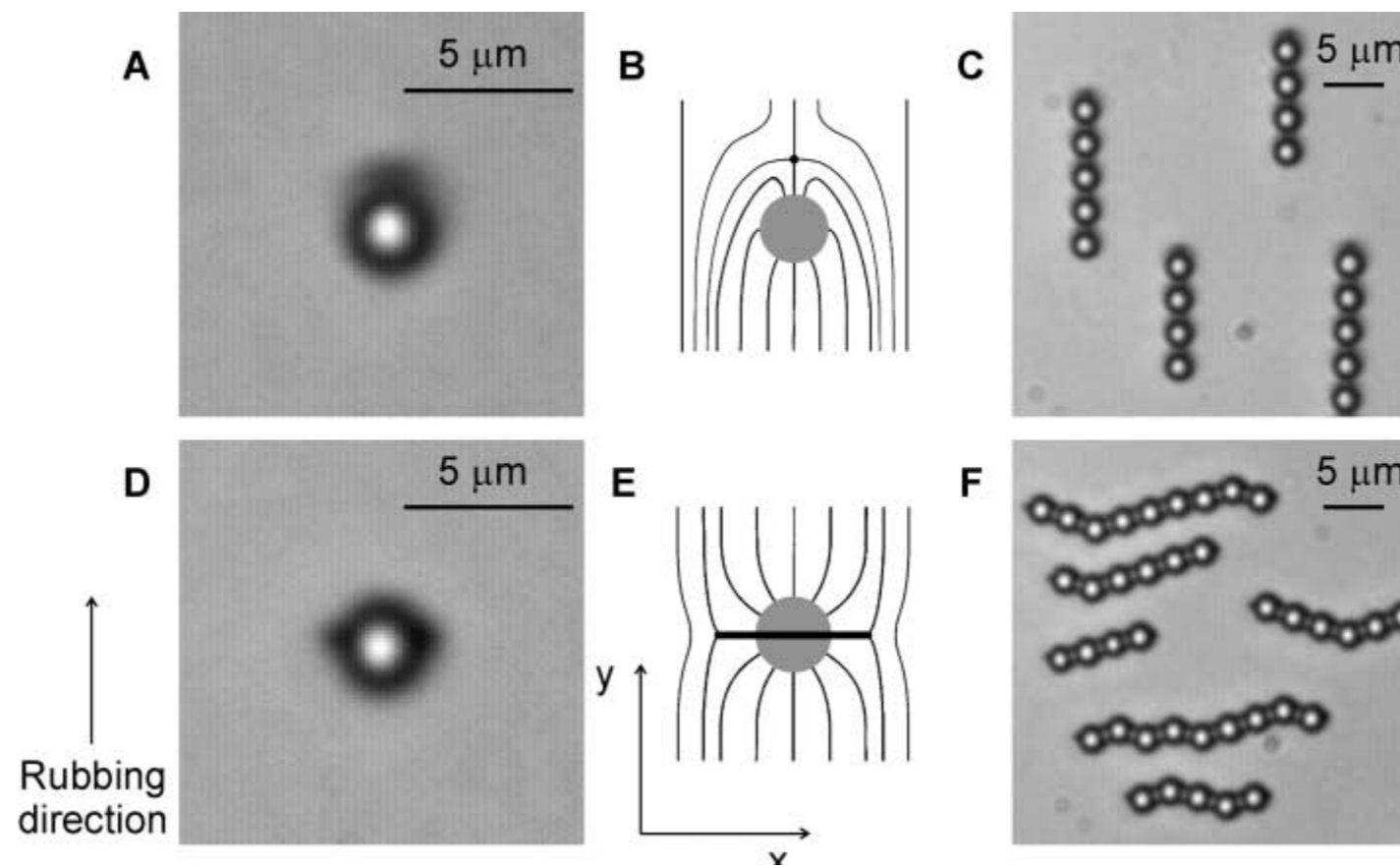

Two-Dimensional Nematic Colloidal Crystals Self-Assembled by Topological Defects

Igor Musevic *et al.*

Science **313**, 954 (2006);

DOI: 10.1126/science.1129660

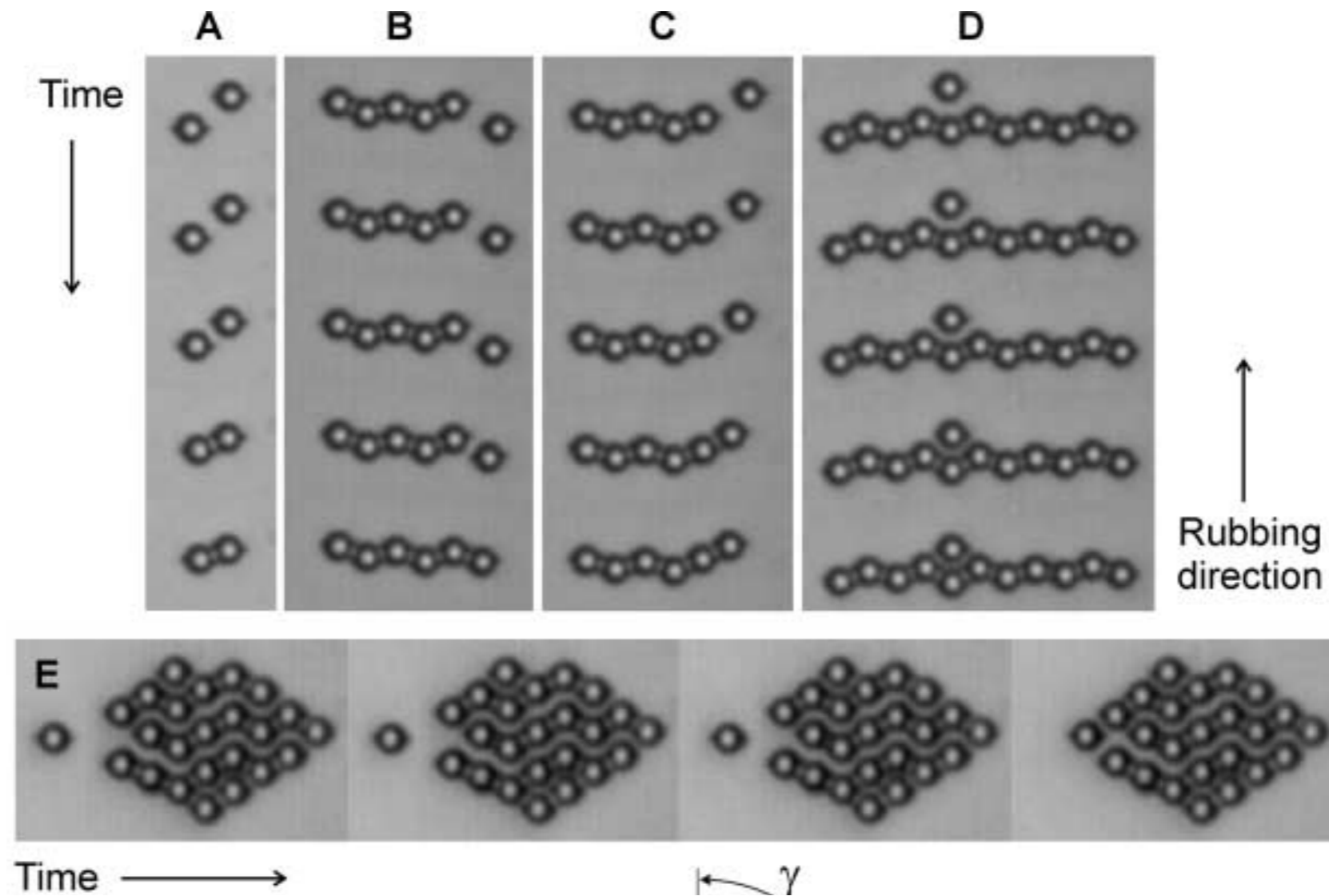

Reconfigurable Knots and Links in Chiral Nematic Colloids

Uros Tkalec *et al.*

Science **333**, 62 (2011);

DOI: 10.1126/science.1205705

